

HAVA DAMPERLERİ

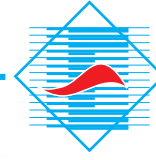



İRİS DAMPER

İris kanal damperi , yuvarlak kanallarda hava akışının kolay ölçümü ve ayarlanması için dizayn edilmiştir. Hem üfleme hem de egzoz kanallarında kullanılırlar. İris damperler galvaniz çelikten imal edilirler. Basınç kaybı ve hava hacmini ölçmek için 2 Adet manometre bağlantısı ile donatılmıştır. İlgili diyagram ve ölçülmüş ΔP değerleriyle istenilen hava akışı ayarlanabilir ya da okunabilir. Ayarlama bir ayar kulpu ile yapılır. Ayarlama yapıldıktan sonra, değer sabitlenir.

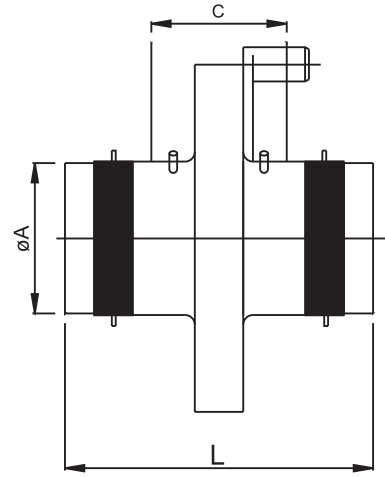
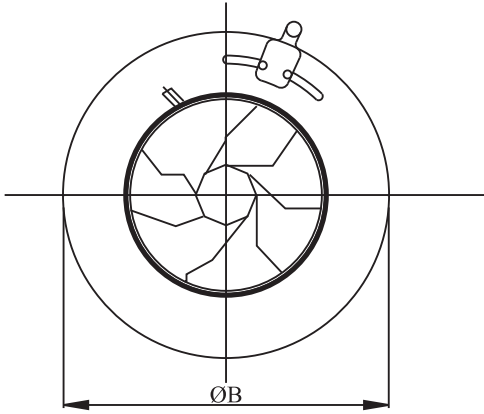

STANDART ÖLÇÜLER

Ebat	ØA	ØB	C	L
100	99	165	50	110
125	124	210	50	110
160	159	230	50	110
200	199	285	50	110
250	249	335	55	135
315	314	410	55	135
355	354	450	55	135
400	398	525	70	190
500	498	655	70	210
630	628	815	70	210

Tüm ölçüler mm'dir.

Montaj Şekilleri

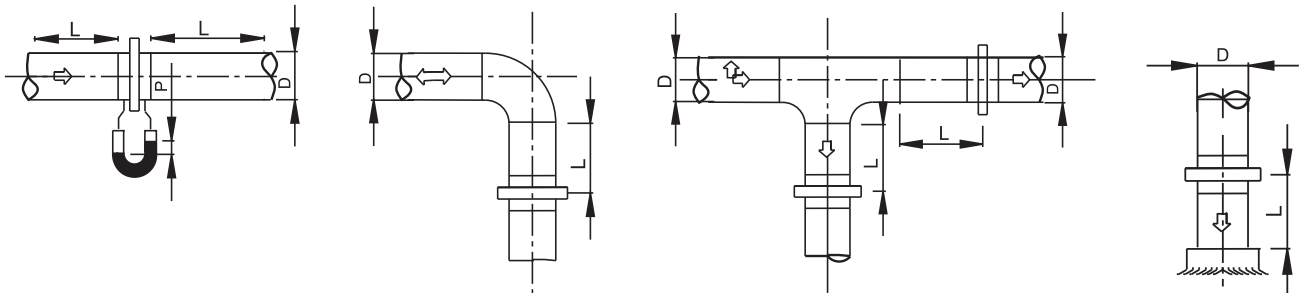

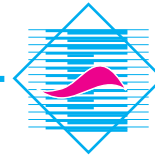

İris Damper Basınç Kaybı

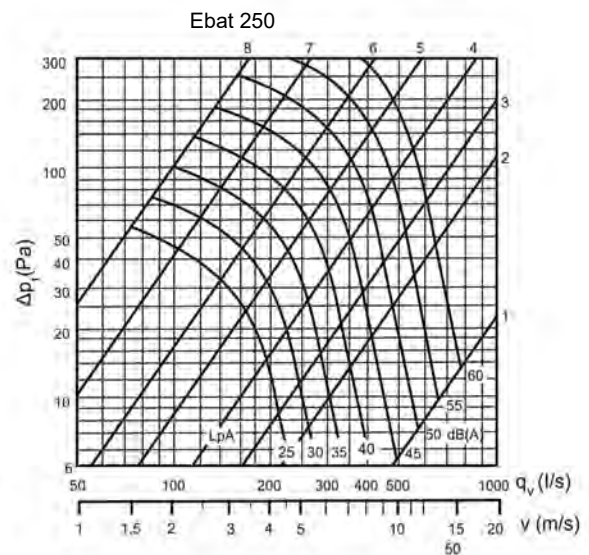
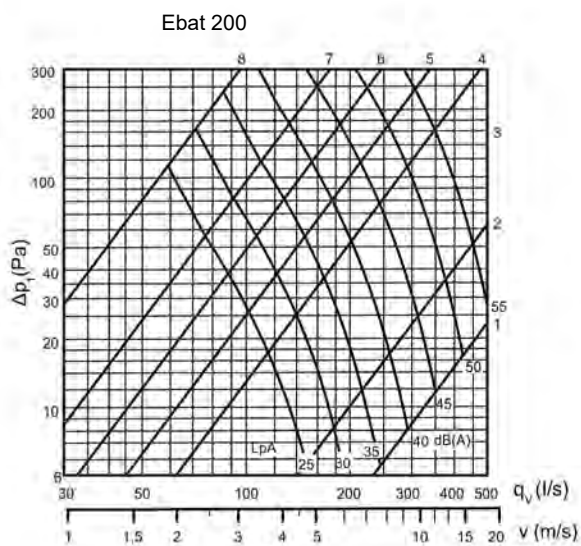
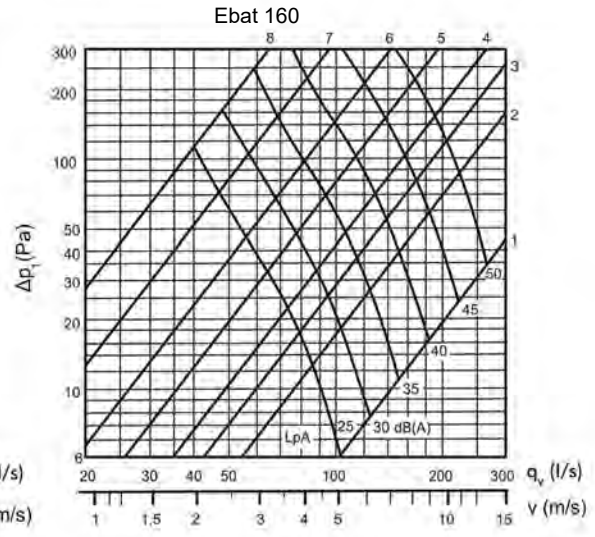
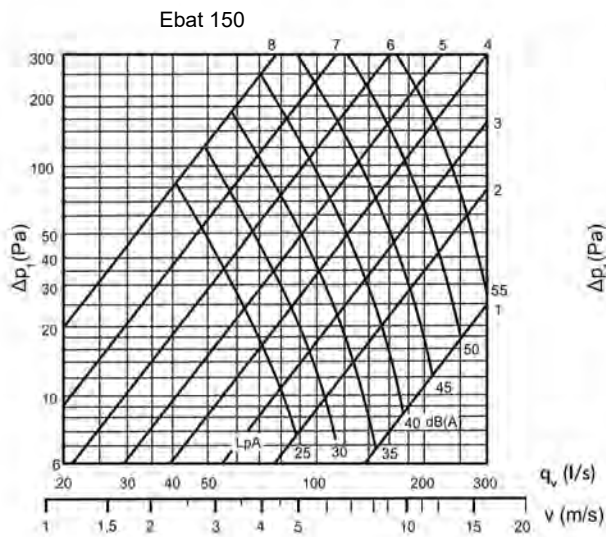
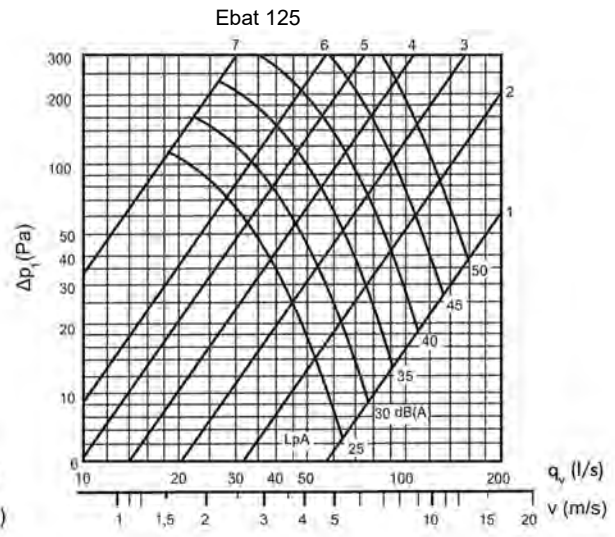
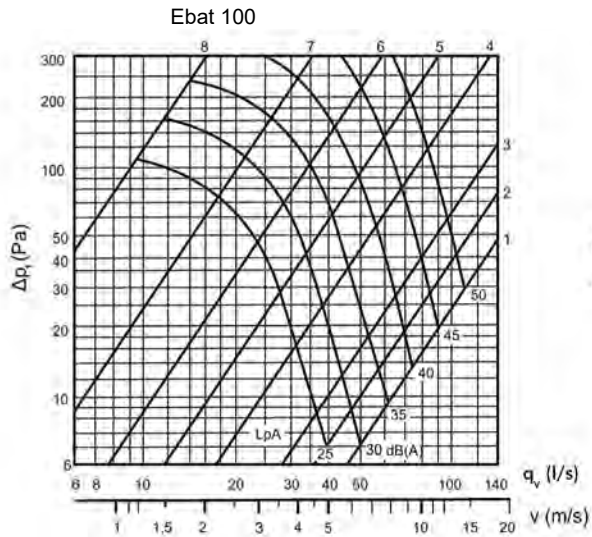

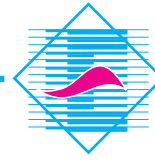

İris Damper Basınç Kaybı

Ebat 315

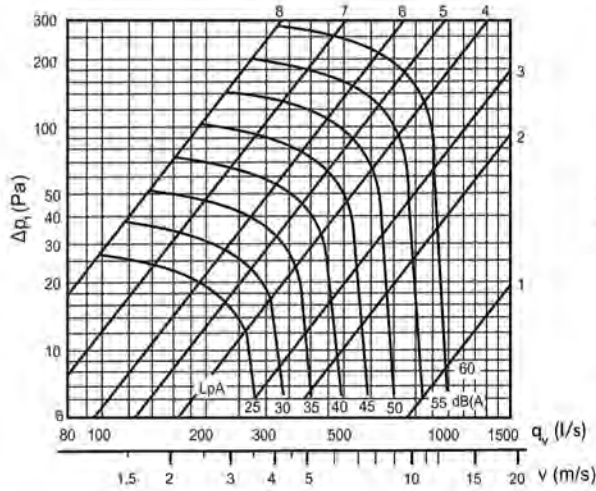

Ebat 355

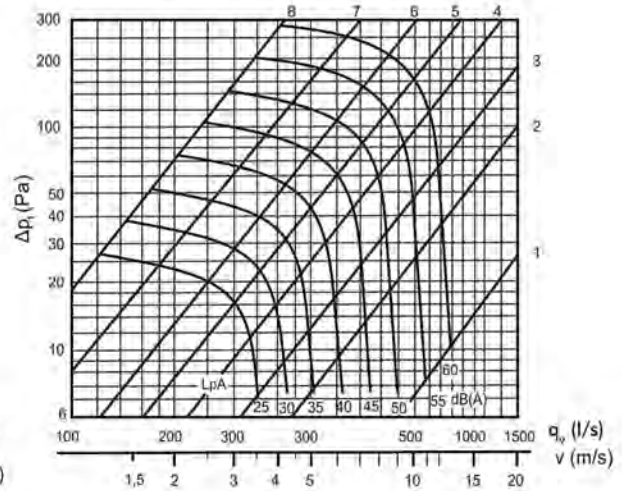

Ebat 400

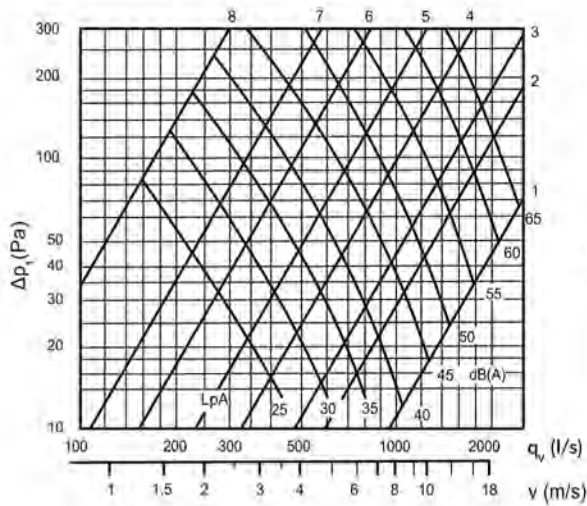

Ebat 500

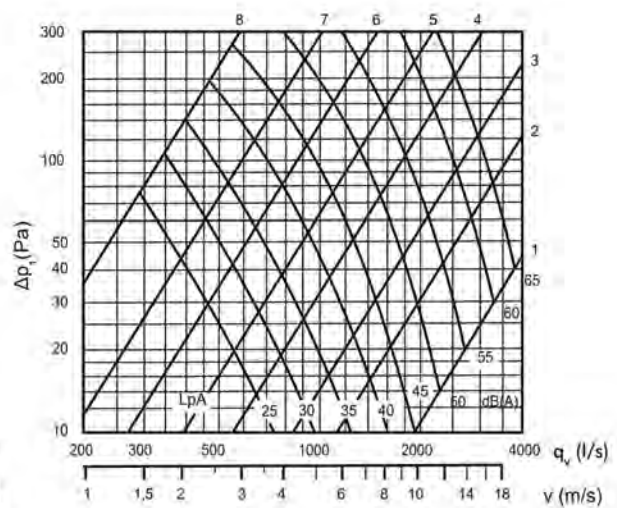

Ebat 630

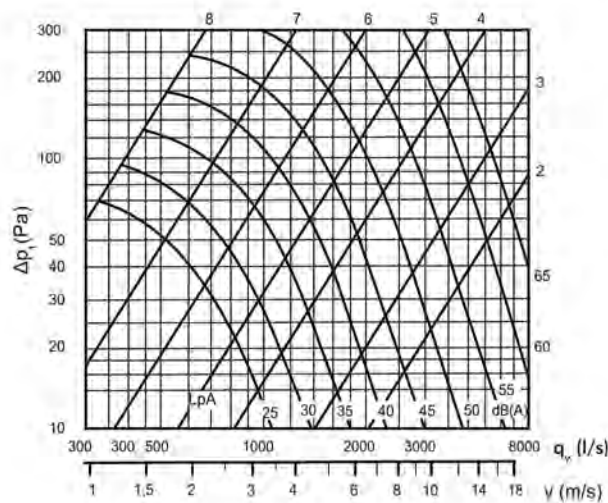

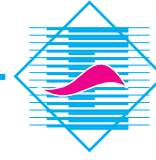

Motor Bağlantıları

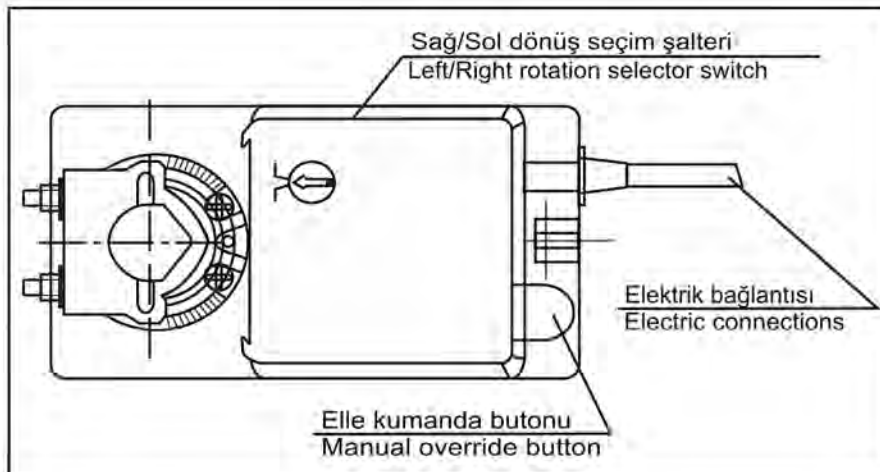
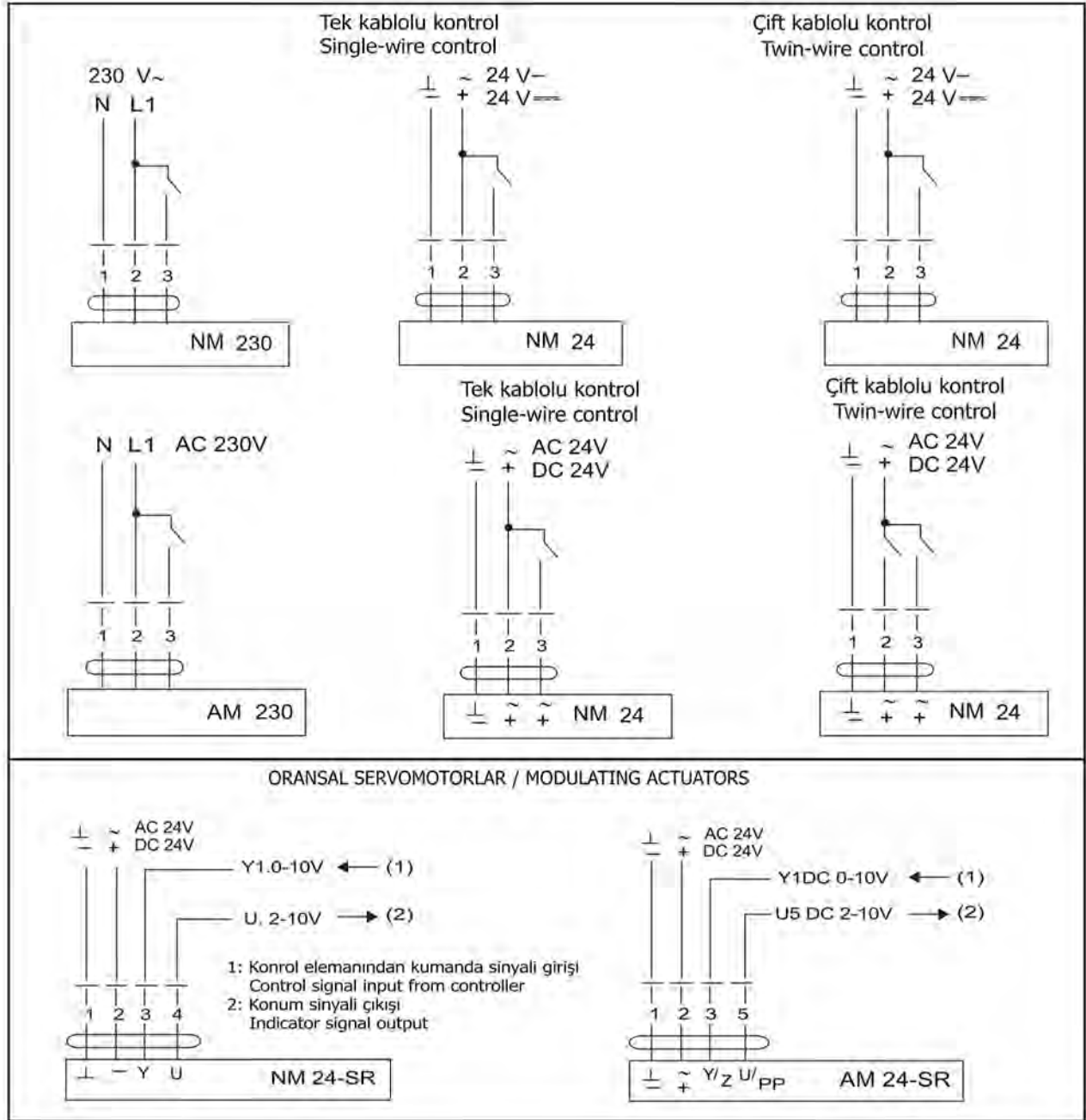



ELEKTROTEKNİK

Klima Sanayi ve Ticaret A.Ş.



Fabrica / Factory-İstanbul
Atatürk Cad. Çağatay Sok. No:3 Sangazi
Sancaktepe 34785 İstanbul/TURKEY
Tel / Phone :+90 216 499 14 64 (pbx)
Faks / Fax :+90 216 499 66 19



Fabrica / Factory-Eskişehir
Eskişehir OSB Şehitler Bulvarı No:29/A
23110 Eskişehir/TURKEY
Tel / Phone :+90 222 236 20 40
Faks / Fax :+90 222 236 20 49



Fabrica / Factory-Eskişehir
Eskişehir OSB Şehitler Bulvarı No:29/B
23110 Eskişehir/TURKEY
Tel / Phone :+90 222 236 20 40
Faks / Fax :+90 222 236 20 49



Fabrica / Factory-Eskişehir
Eskişehir OSB 21.Cad. No:15
23110 Eskişehir/TURKEY
Tel / Phone :+90 222 236 20 40
Faks / Fax :+90 222 236 20 49