

DEPLASMANLI TEKSTİL DİFÜZÖRLER

DDT

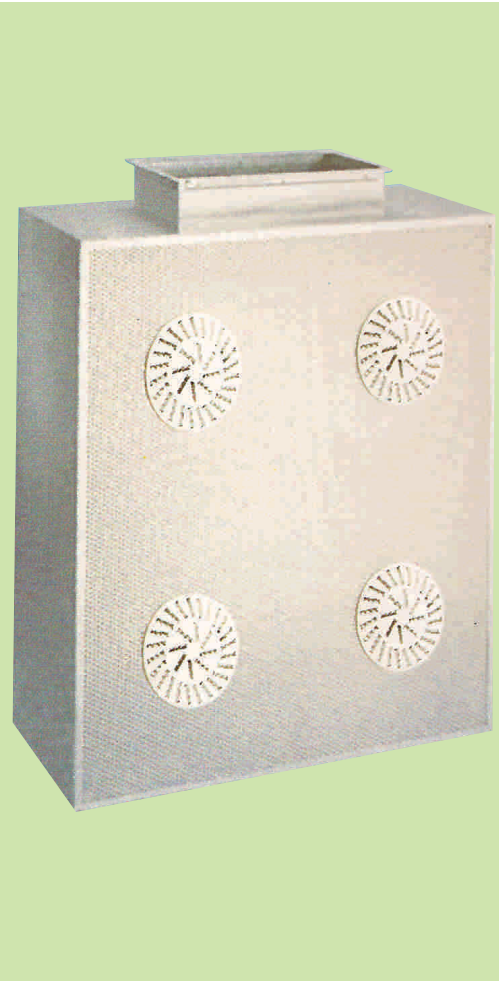

ELEKTROTEKNİK

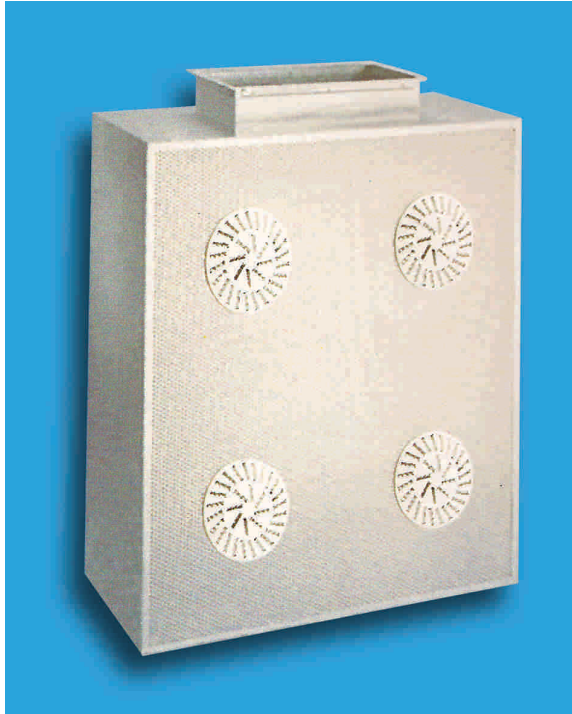
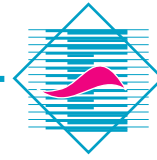

DDT-01

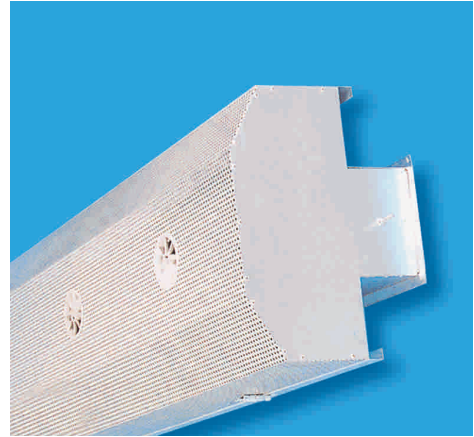

DDT-02

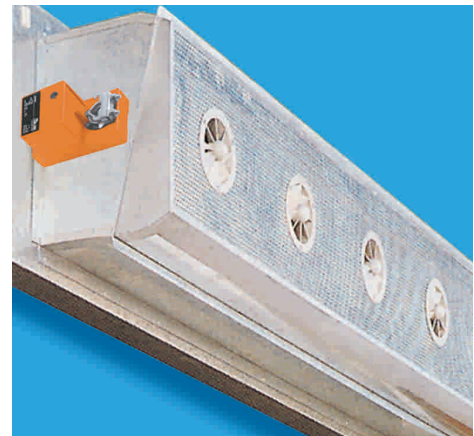

DDT-03

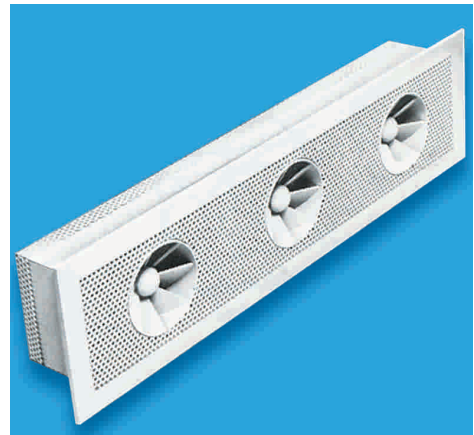

DDT-04

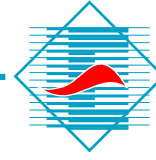

DEPLASMANLI TEKSTİL DİFÜZÖRLER DDT-04

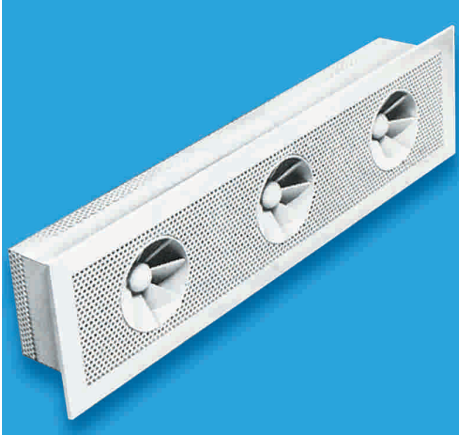

- Düşük türbülanslı deplasmanlı akışı
- Tavana monte edilebilme
- 250-750 m³/h debi ihtiyaçlarında kullanılabilme
- Ortam havası ile üfleme havası arasındaki sıcaklık farkı 8K

ÖLÇÜLER VE DEĞİŞİK MODELLER

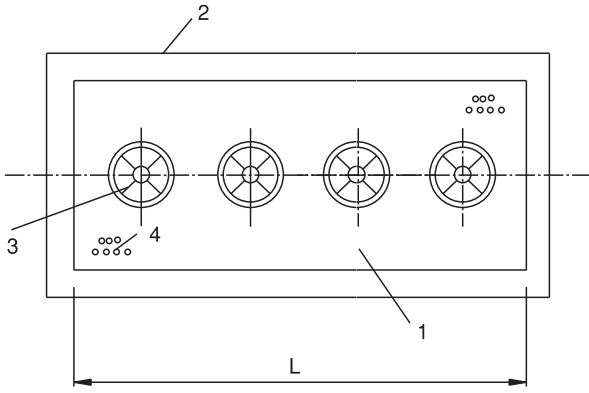

- 1- Gövde
2- Çerçeve
3- Türbülanslı difüzör
4- Perfore saç levha

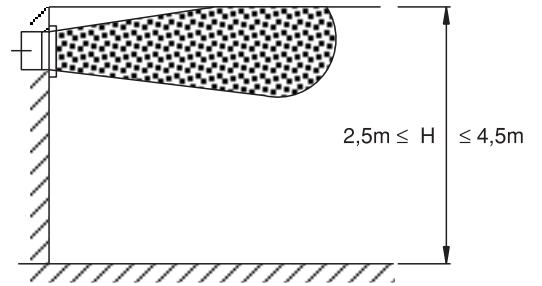
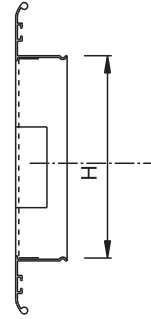

Şekil 2 Hava akış modeli

Şekil 1 Deplasmanlı difüzör ölçüleri

Standart uzunluk L mm	Standart yükseklik H mm	Türbülanslı difüzör çapı	Türbülanslı difüzör sayısı
425	125	Ø100	2
625	125	Ø100	3
825	125	Ø100	4
425	160	Ø125	2
625	160	Ø125	3
825	160	Ø125	4



ELEKTROTEKNİK

Klima Sanayi ve Ticaret A.Ş.



Fabrica / Factory-Istanbul

Atatürk Cad. Çağatay Sok. No:3 Sarıgazi
Sancaktepe 34785 İstanbul/TURKEY
Tel / Phone :+90 216 499 14 64 (pbx)
Faks / Fax :+90 216 499 66 19



Fabrica / Factory-Eskişehir

Eskişehir OSB Şehitler Bulvarı No:29/A
23110 Eskişehir/TURKEY
Tel / Phone :+90 222 236 20 40
Faks / Fax :+90 222 236 20 49



Fabrica / Factory-Eskişehir

Eskişehir OSB Şehitler Bulvarı No:29/B
23110 Eskişehir/TURKEY
Tel / Phone :+90 222 236 20 40
Faks / Fax :+90 222 236 20 49



Fabrica / Factory-Eskişehir

Eskişehir OSB 21.Cad. No:15
23110 Eskişehir/TURKEY
Tel / Phone :+90 222 236 20 40
Faks / Fax :+90 222 236 20 49